

# Unidrive M400 (Frame 1 to 4)

## Quick Start Guide

This guide is intended to provide basic information required in order to set-up a drive to run a motor. For more detailed installation information, please refer to the *Unidrive M400 User Guide* which is available to download from

[www.controltechniques.com/userguides](http://www.controltechniques.com/userguides) or [www.leroy-somer.com/manuals](http://www.leroy-somer.com/manuals).

## 1 Safety information



This guide does not include safety information. Incorrect installation or operation of the drive, could cause personnel injury or equipment damage. For essential safety information, please refer to the *Unidrive M400 User Guide* or the safety booklet supplied with the drive.

## 2 Product information

### 2.1 Ratings

Model	Input phases ph	Max. cont input current A	Max input fuse rating		Nominal cable size				Output current		
			1 Ph A	3 Ph A	European		USA		Max. cont output current A	Nominal power kW	Motor power hp
					Input mm <sup>2</sup>	Output mm <sup>2</sup>	Input AWG	Output AWG			
01100017	1	8.7	10		1	1	16	16	1.7	0.25	0.33
01100024	1	11.1	16		1	1	14	16	2.4	0.37	0.5
01200017	1	4.5	6		1	1	16	16	1.7	0.25	0.33
01200024	1	5.3	6		1	1	16	16	2.4	0.37	0.5
01200033	1	8.3	10		1	1	16	16	3.3	0.55	0.75
01200042	1	10.4	16		1	1	16	16	4.2	0.75	1
02100042	1	18.8	20		2.5	1	12	16	4.2	0.75	1
02100056	1	24	25		4	1	10	16	5.6	1.1	1.5
02200024	1 / 3	5.3/4.1	6	6	1	1	16	16	2.4	0.37	0.5
02200033	1 / 3	8.3/6.7	10	10	1	1	16	16	3.3	0.55	0.75
02200042	1 / 3	10.4/7.5	16	10	1	1	16	16	4.2	0.75	1
02200056	1 / 3	14.9/11.3	20	15	2.5/1.5	1	12/14	16	5.6	1.1	1.5
02200075	1 / 3	18.1/13.5	20	15	2.5	1	12	16	7.5	1.5	2
02400013	3	2.4		6	1	1	16	16	1.3	0.37	0.5
02400018	3	2.9		6	1	1	16	16	1.8	0.55	0.75
02400023	3	3.5		6	1	1	16	16	2.3	0.75	1
02400032	3	5.1		6	1	1	16	16	3.2	1.1	1.5
02400041	3	6.2		10	1	1	16	16	4.1	1.5	2
03200100	1 / 3	23.9/17.7	25	20	4	1.5	10/12	14	10	2.2	3
03400056	3	8.7		10	1	1	14	16	5.6	2.2	3
03400073	3	12.2		16	1.5	1	12	16	7.3	3	3
03400094	3	14.8		16	2.5	1.5	12	14	9.4	4	5
04200133	1 / 3	23.7/16.9	25	20	4/2.5	2.5	10	12	13.3	3	3
04200176	3	21.3		25	4	2.5	10	12	17.6	4	5
04400135	3	16.3		20	2.5	2.5	10	12	13.5	5.5	7.5
04400170	3	20.7		25	4	2.5	10	12	17	7.5	10

**NOTE**

The nominal cable sizes shown in the table above, are provided as a guide only. Ensure that the cables used conform to the local wiring regulations.

**Figure 2-1 Model number structure**

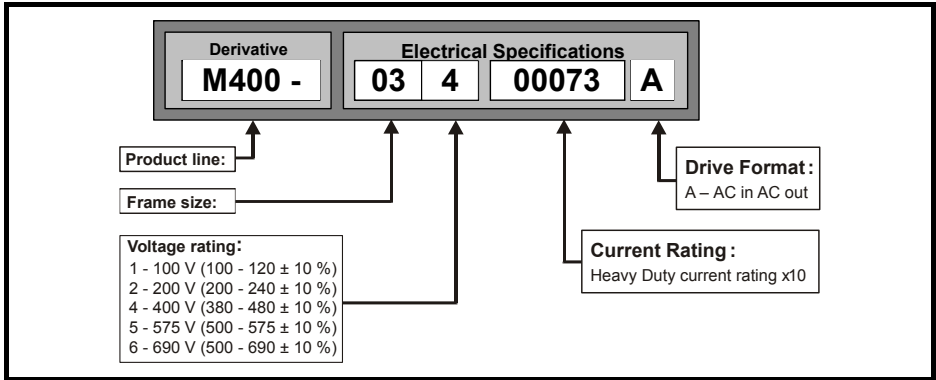

### 3 Mechanical installation

The drives can be panel mounted with 0 mm space between the drives. For further information on mechanical installation refer to the *Unidrive M400 User Guide*.

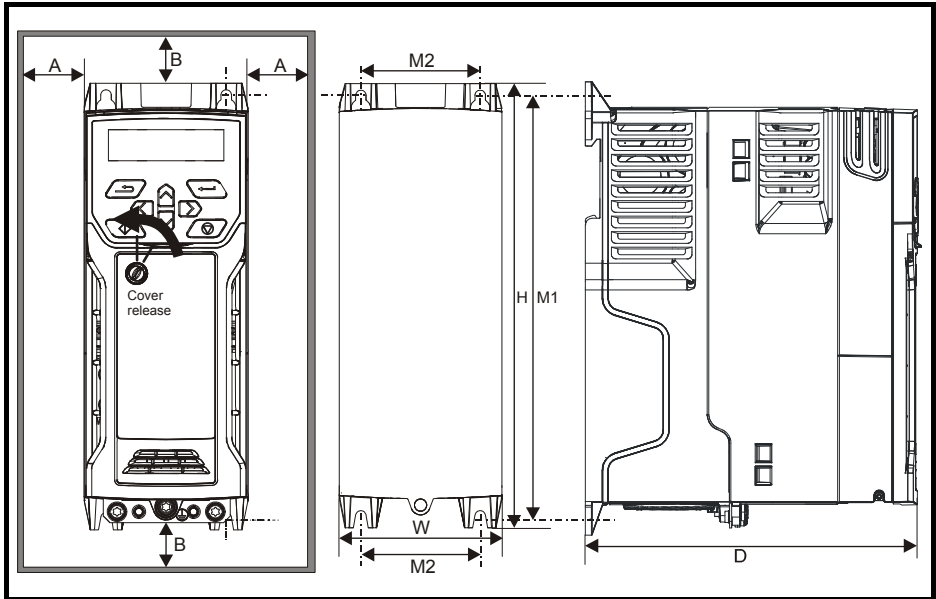

To remove the terminal cover, use a flat bladed screwdriver to rotate the terminal cover locating clip by approximately 30° in a counter clockwise direction, and then slide the cover down.

Drive Size	H		W		D		M1		M2		Ø		A		B	
	mm	in	mm	in	mm	in	mm	in	mm	in	mm	in	mm	in	mm	in
1	160	6.30	75	2.95	130	5.12	143	5.70	53	2.08	5	0.2	0.00	0.00	100	3.93
2	205	8.07	78	3.07	150	5.91	194	7.63	55	2.17	5	0.2				
3	226	8.90	90	3.54	160	6.30	215	8.46	70.7	2.80	5	0.2				
4	277	10.91	115	4.53	175	6.89	265	10.43	86	3.40	6	0.23				

**Table 3-1 Tools required**

Tool	Location	Size 1	Size 2	Size 3	Size 4
Small terminal screwdriver	Control, relay and STO terminals	✓	✓	✓	✓
3mm Flat-bladed screwdriver	Power terminals	✓			
5mm Flat-bladed screwdriver	Terminal cover	✓	✓	✓	✓
Pozidrive 1 screwdriver	AC power terminals		✓		
Pozidrive 2 screwdriver	Power terminals		✓	✓	✓
Torx 10 driver	EMC & MOV screws	✓	✓	✓	✓
Torx 15 driver	Fan screw	✓			
Torx 20 driver	Fan screw		✓	✓	✓

**Table 3-2 Recommended torque settings**

Model size	Terminal block description	Torque settings
All	Control terminals	0.2 N m (0.15 lb ft)
	Relay terminals	0.5 N m (0.37 lb ft)
1	Power terminals	0.5 N m (0.37 lb ft)
2, 3, 4		1.4 N m (1.03 lb ft)

## 4 Feature diagram (size 2 shown)

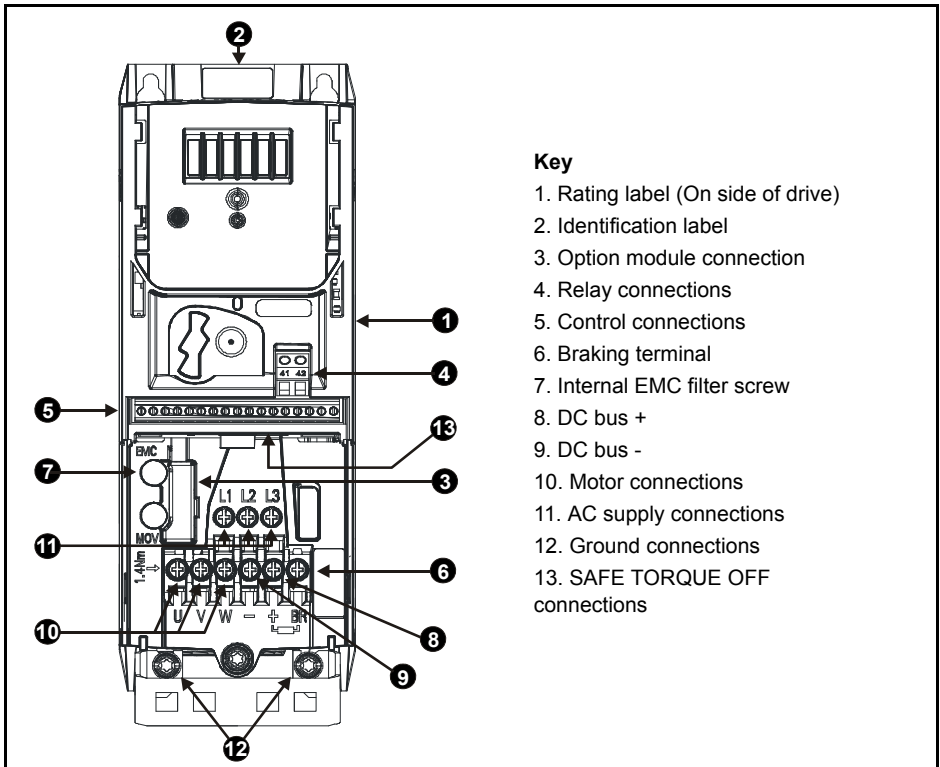

## 5 Electrical installation

An overlay of the electrical connections / terminals is included on the back page of this manual.

## 6 Keypad and display

The keypad and display provide information to the user regarding the operating status of the drive and trip codes, and provide the means for changing parameters, stopping and starting the drive, and the ability to perform a drive reset.

**Figure 6-1 Unidrive M400 keypad detail**

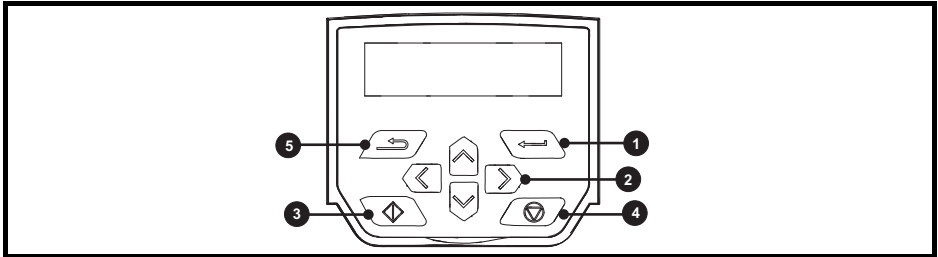





- (1) The *Enter* button is used to enter parameter view or edit mode, or to accept a parameter edit.
- (2) The *Navigation* keys can be used to select individual parameters or to edit parameter values. In keypad mode, the '*Up*' and '*Down*' keys are also used to increase or decrease the motor speed.
- (3) The *Start* key is used to start the drive in keypad mode.
- (4) The *Stop / Reset* key is used to stop and reset the drive in keypad mode. It can also be used to reset the drive in terminal mode.
- (5) The *Escape* key is used to exit from the parameter edit / view mode or disregard a parameter edit.

**NOTE** The keypad is not supplied with the drive.

# 7 Running the motor

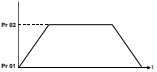
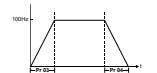
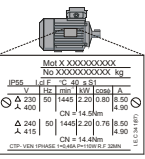
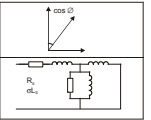
This section takes a new user through all the essential steps to running a motor for the first time. Section 4 provides the minimum connections required to connect and run a motor.

Action	Detail	
Before power up	Ensure: <ul style="list-style-type: none"> <li>The drive enable signal is not given, terminal 31 and 34 is open</li> <li>The run signal is not given, terminal 12/13 is open</li> <li>The motor is connected to the drive</li> <li>The motor connection is correct for the drive <math>\Delta</math> or Y</li> <li>The correct supply voltage is connected to the drive</li> </ul>	
Power up the drive	Verify that the correct user drive mode is displayed as the drive powers up. If the mode is incorrect, Set Pr <b>00.079</b> to the correct mode, then press the  stop/reset button to save the parameters. Ensure: <ul style="list-style-type: none"> <li>The drive displays: Inhibit</li> </ul>	
Enter minimum and maximum speeds	Enter: <ul style="list-style-type: none"> <li>Minimum speed Pr <b>00.001</b> (Hz)</li> <li>Maximum speed Pr <b>00.002</b> (Hz)</li> </ul>	
Enter accel and decel rates	Enter: <ul style="list-style-type: none"> <li>Acceleration rate Pr <b>00.003</b> (s/100 Hz)</li> <li>Deceleration rate Pr <b>00.004</b> (s/100 Hz)</li> </ul>	
Enter motor nameplate details	Enter: <ul style="list-style-type: none"> <li>Motor rated current in Pr <b>00.006</b> (A)</li> <li>Motor rated speed in Pr <b>00.007</b> (rpm)</li> <li>Motor rated voltage in Pr <b>00.008</b> (V)</li> <li>Motor rated power factor in Pr <b>00.009</b></li> <li>If the motor is not a standard 50/60 Hz motor, set Pr <b>00.039</b> accordingly</li> </ul>	
<b>Ready to autotune</b>		
Autotune	The drive is able to perform either a stationary or a rotating autotune. The motor must be at a standstill before an autotune is enabled. To perform an autotune: <ul style="list-style-type: none"> <li>Set Pr <b>00.038</b> = 1 for a stationary autotune or set Pr <b>00.038</b> = 2 for a rotating autotune</li> <li>Close the drive enable signal (apply +24 V to terminal 31 &amp; 34). The drive will display 'Ready'.</li> <li>Close the run signal (apply +24 V to terminal 12 or 13). The lower display will flash 'tuning' while the drive is performing the autotune.</li> <li>Wait for the drive to display 'Inhibit' and for the motor to come to a standstill.</li> <li>Remove the drive enable and run signal from the drive.</li> </ul>	
Autotune complete	When the autotune has been completed, Pr <b>00.038</b> will be set to 0	
<b>Save parameters</b>		
Save parameters	Select 'SAVE' in Pr <b>mm.000</b> (alternatively enter a value of 1000) and press the  Stop / Reset button to save parameters.	
<b>Ready to run</b>		
Run	The drive is now ready to run the motor.	
Increasing and decreasing speed	Turning the speed potentiometer will increase and decrease the speed of the motor.	
Stopping	To stop the motor under ramp control, open either the run forward or run reverse terminal. If the enable terminal is opened while the motor is running, the motor will coast to a stop.	

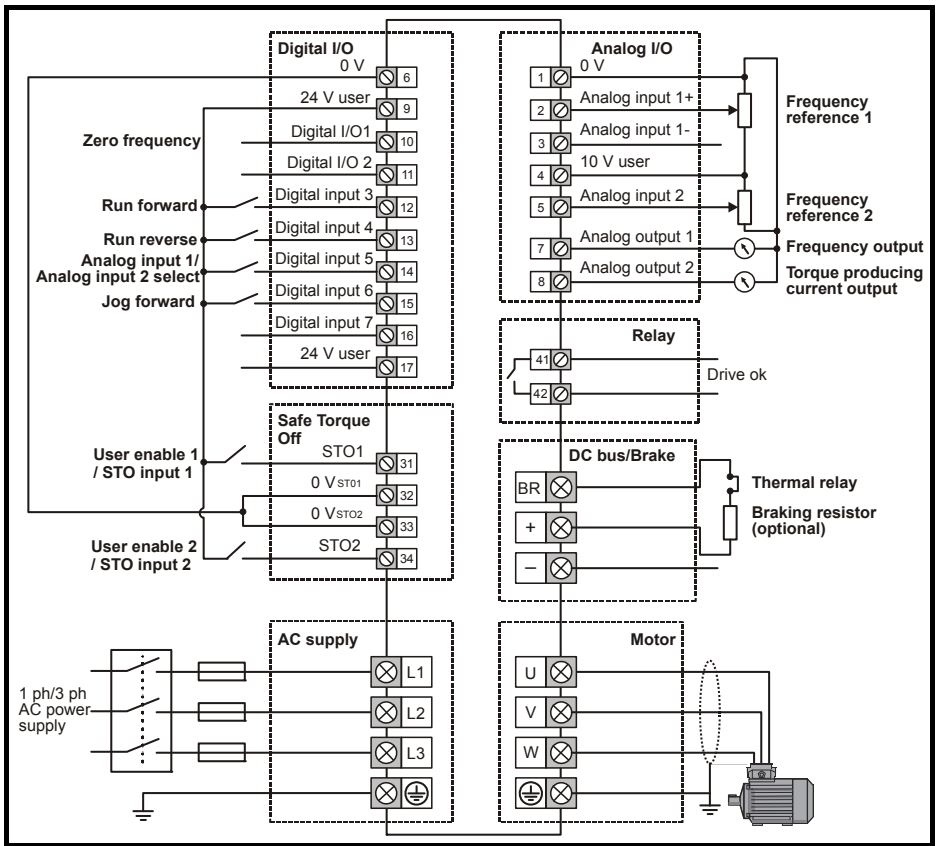

**NOTE**

The 0 V terminals on the SAFE TORQUE OFF are isolated from each other and the 0 V common.



0478-0040-02